

Fig. 2

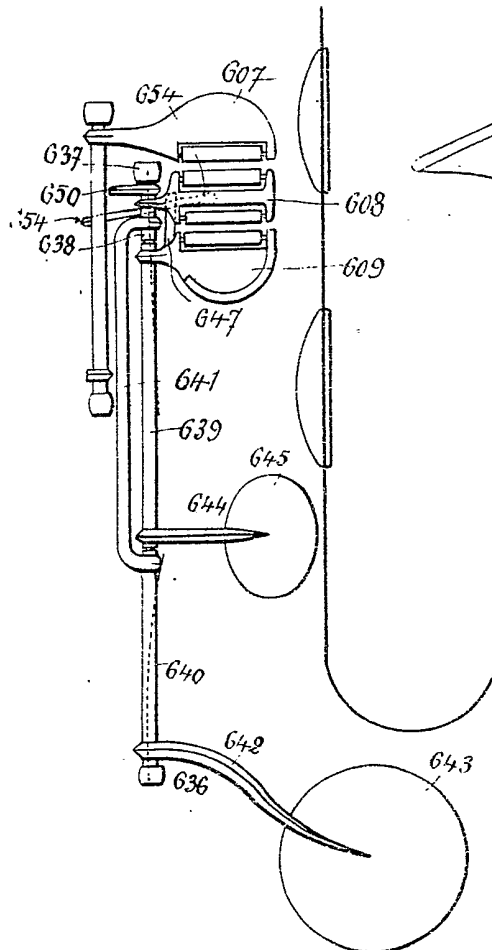

Fig. 4

