

Fig. 2

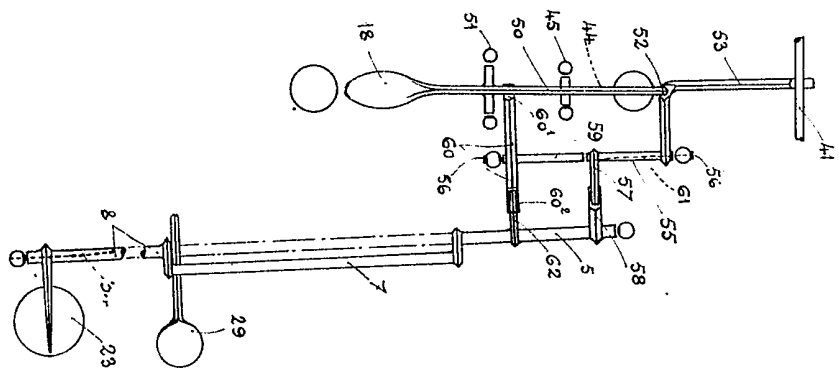

Fig. 1

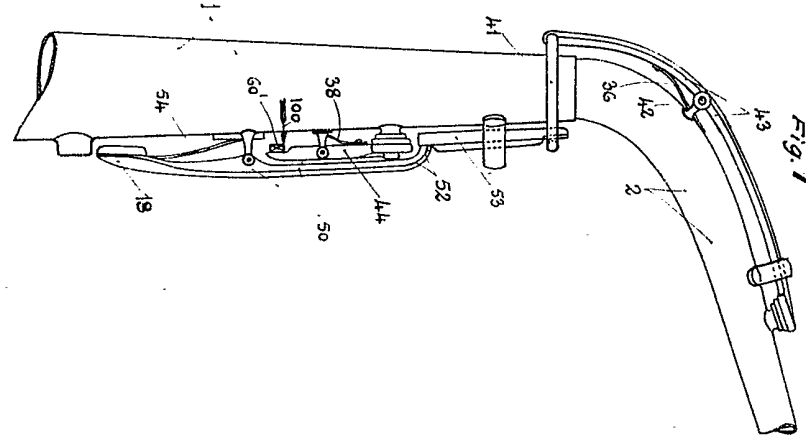

Fig. 4

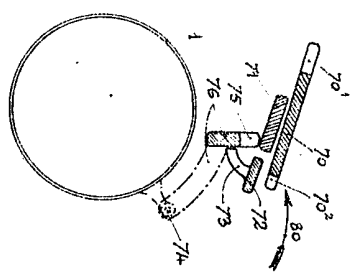

Fig. 3

