

Dec. 22, 1931.

A. LOOMIS

1,837,227

TUNING DEVICE FOR MUSICAL INSTRUMENTS

Filed May 17, 1930

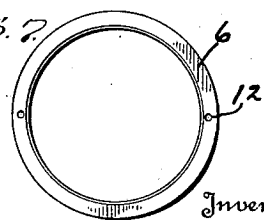
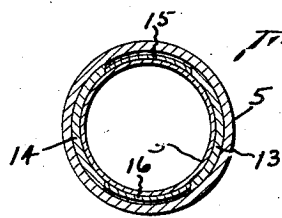
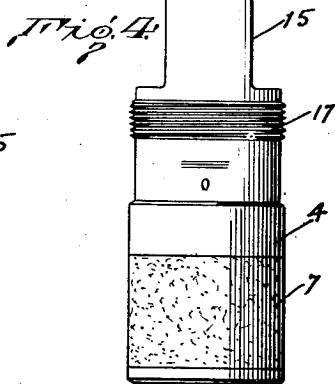
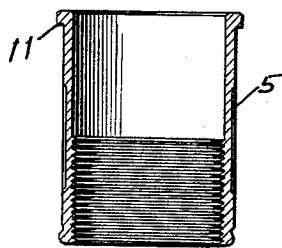
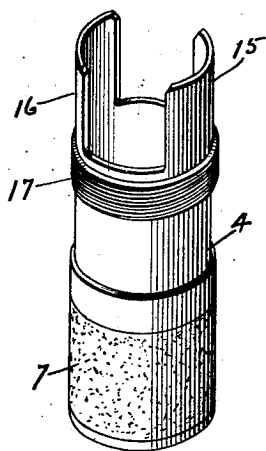
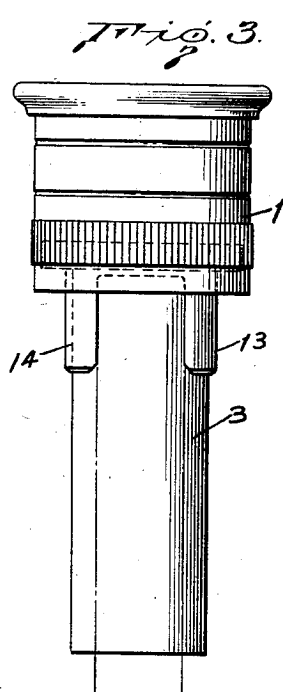
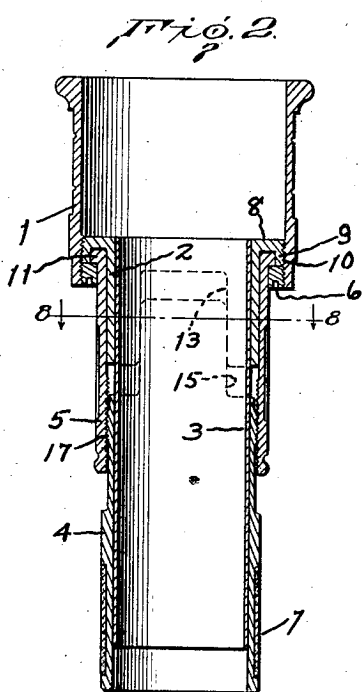
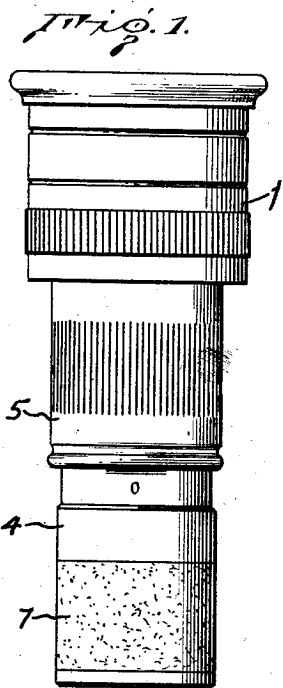

Inventor

Allen Loomis

By

Louis C. Vanderlip.

Attorney