

3/4

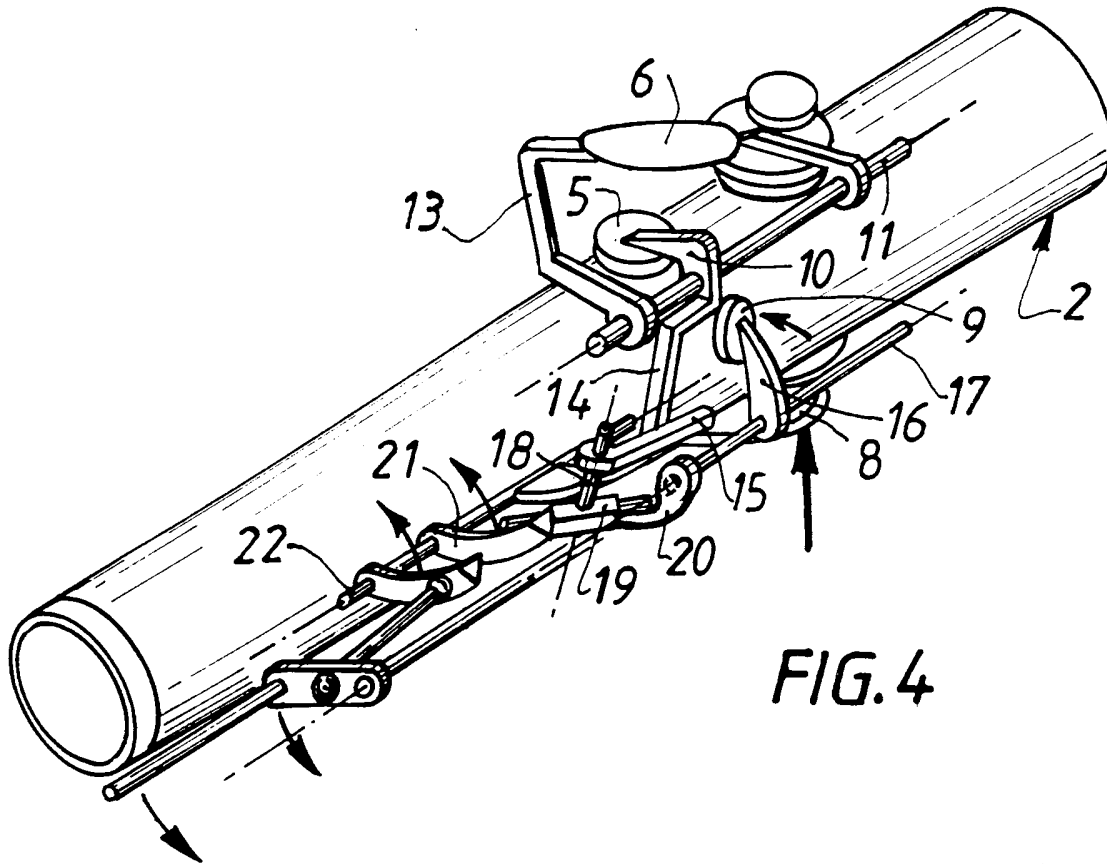

FIG. 4

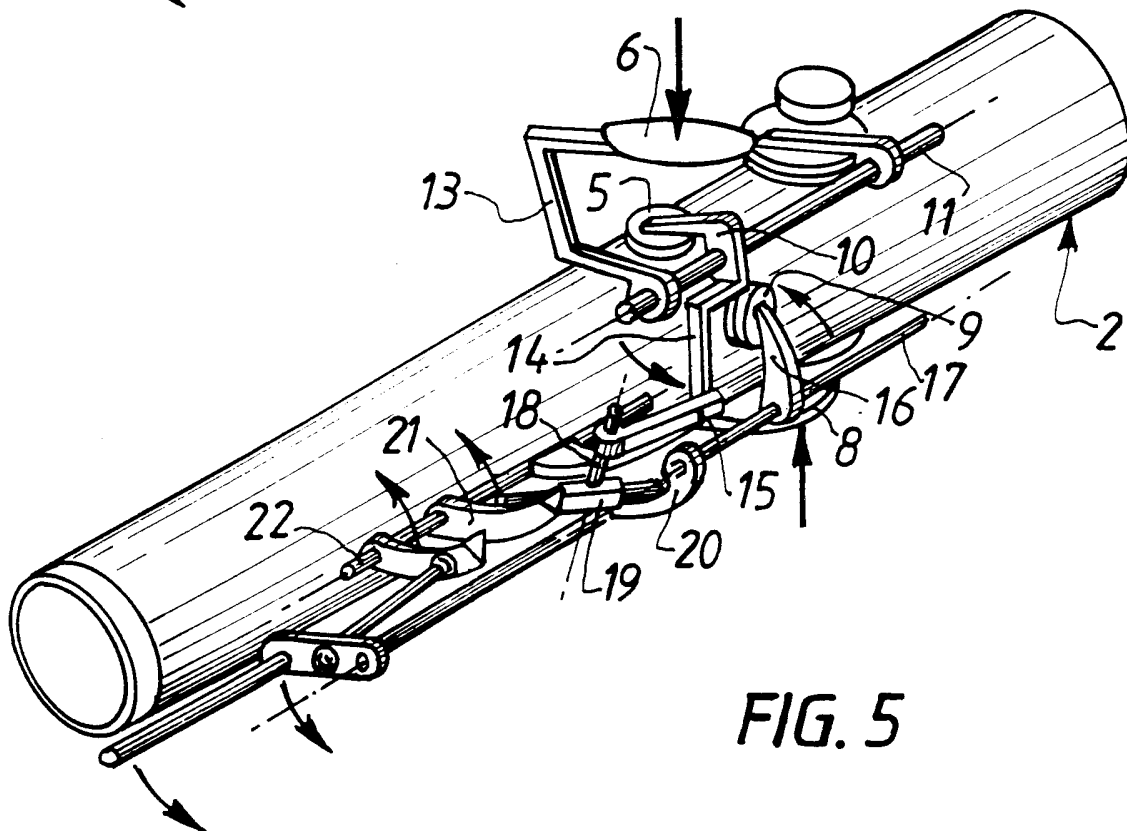

FIG. 5