

1/4

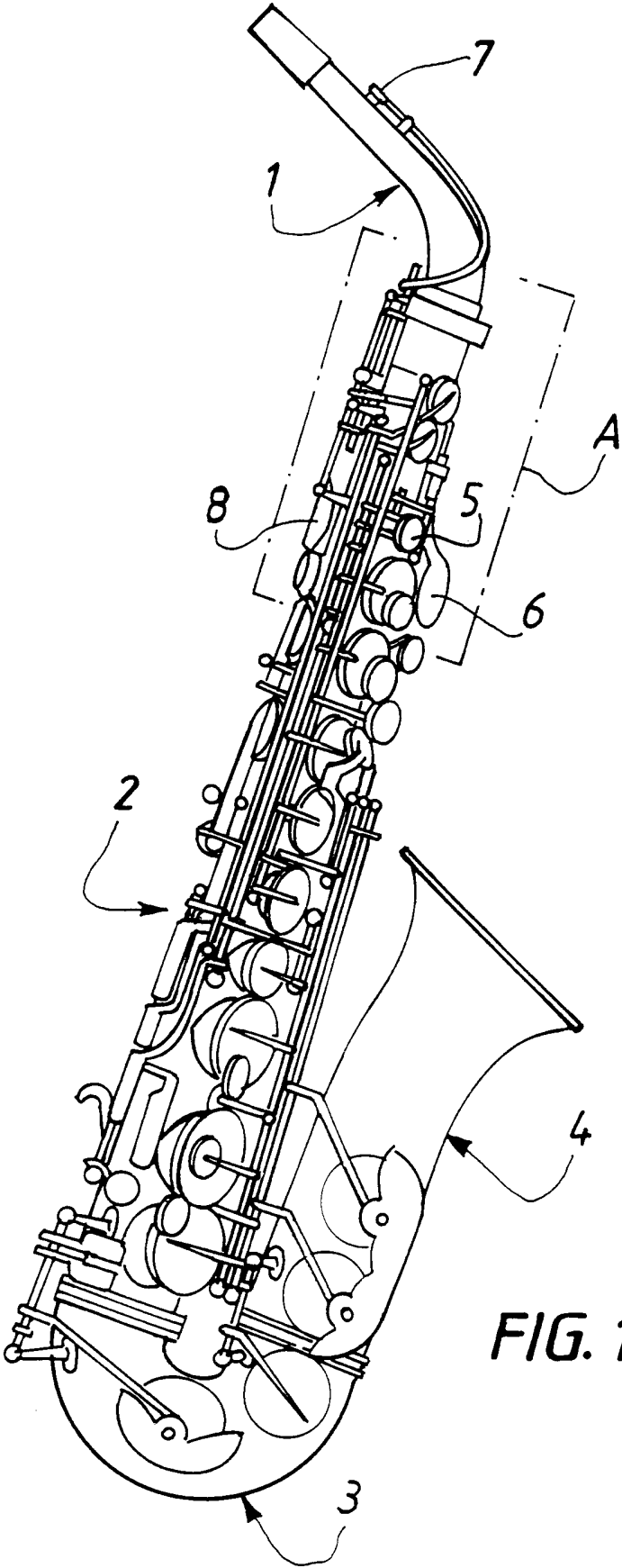

FIG. 1